

O COME, LET US ADORE HIM,
CHRIST THE LORD

O COME, LET US ADORE HIM,
CHRIST THE LORD

O COME, LET US ADORE HIM,
CHRIST THE LORD

O COME, LET US ADORE HIM,
CHRIST THE LORD

O COME, LET US ADORE HIM,
CHRIST THE LORD

O COME, LET US ADORE HIM,
CHRIST THE LORD

O COME, LET US ADORE HIM,
CHRIST THE LORD

O COME, LET US ADORE HIM,
CHRIST THE LORD

O COME, LET US ADORE HIM,
CHRIST THE LORD

O COME, LET US ADORE HIM,
CHRIST THE LORD

O COME, LET US ADORE HIM,
CHRIST THE LORD

O COME, LET US ADORE HIM,
CHRIST THE LORD

O COME, LET US ADORE HIM,
CHRIST THE LORD

O COME, LET US ADORE HIM,
CHRIST THE LORD

O COME, LET US ADORE HIM,
CHRIST THE LORD

O COME, LET US ADORE HIM,
CHRIST THE LORD

O COME, LET US ADORE HIM,
CHRIST THE LORD

O COME, LET US ADORE HIM,
CHRIST THE LORD

O COME, LET US ADORE HIM,
CHRIST THE LORD

O COME, LET US ADORE HIM,
CHRIST THE LORD

O COME, LET US ADORE HIM,
CHRIST THE LORD

O COME, LET US ADORE HIM,
CHRIST THE LORD

O COME, LET US ADORE HIM,
CHRIST THE LORD

O COME, LET US ADORE HIM,
CHRIST THE LORD

O COME, LET US ADORE HIM,
CHRIST THE LORD

O COME, LET US ADORE HIM,
CHRIST THE LORD

O COME, LET US ADORE HIM,
CHRIST THE LORD

O COME, LET US ADORE HIM,
CHRIST THE LORD

O COME, LET US ADORE HIM,
CHRIST THE LORD

O COME, LET US ADORE HIM,
CHRIST THE LORD

O COME, LET US ADORE HIM,
CHRIST THE LORD

O COME, LET US ADORE HIM,
CHRIST THE LORD

O COME, LET US ADORE HIM,
CHRIST THE LORD

O COME, LET US ADORE HIM,
CHRIST THE LORD

O COME, LET US ADORE HIM,
CHRIST THE LORD

O COME, LET US ADORE HIM,
CHRIST THE LORD

O COME, LET US ADORE HIM,
CHRIST THE LORD

O COME, LET US ADORE HIM,
CHRIST THE LORD

O COME, LET US ADORE HIM,
CHRIST THE LORD

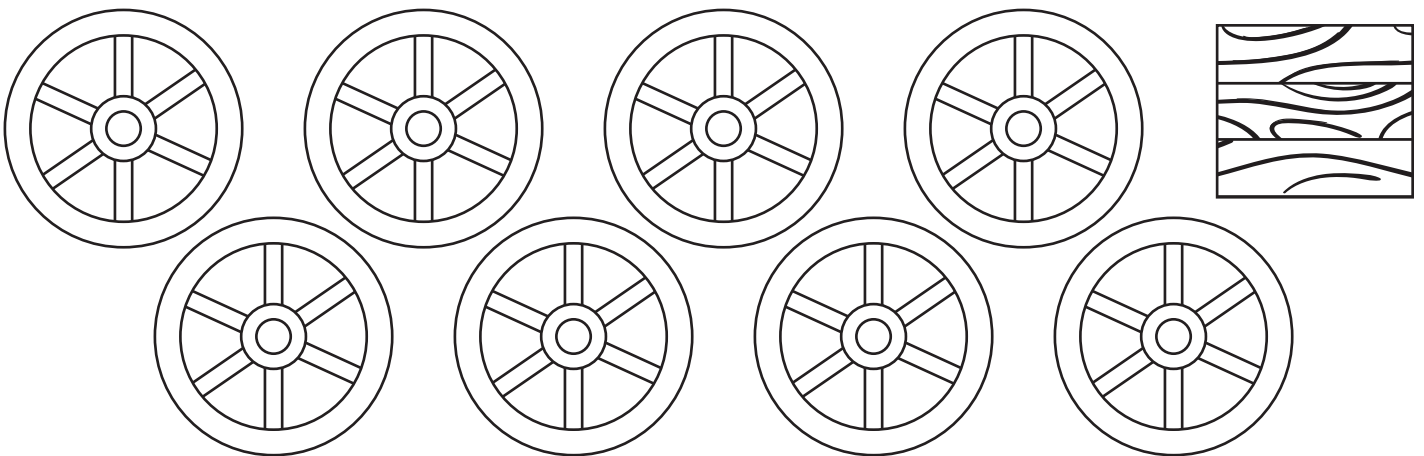
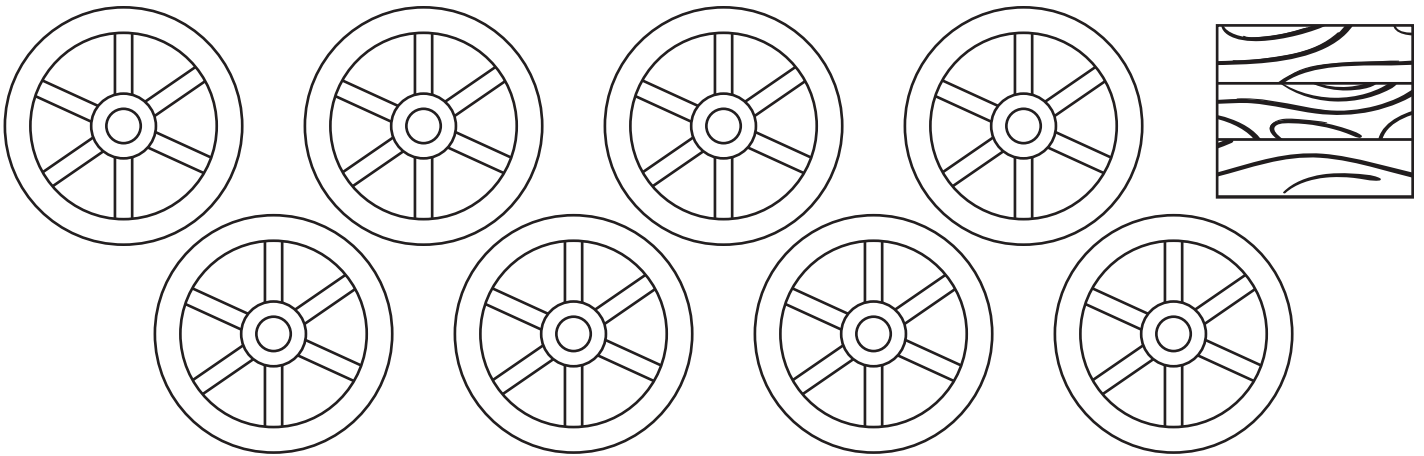
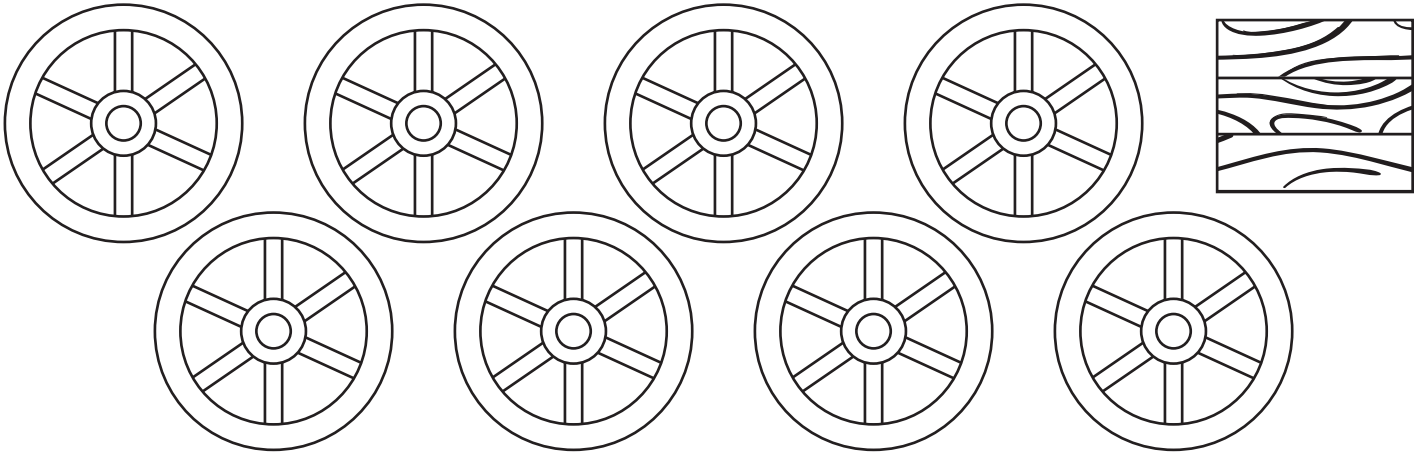
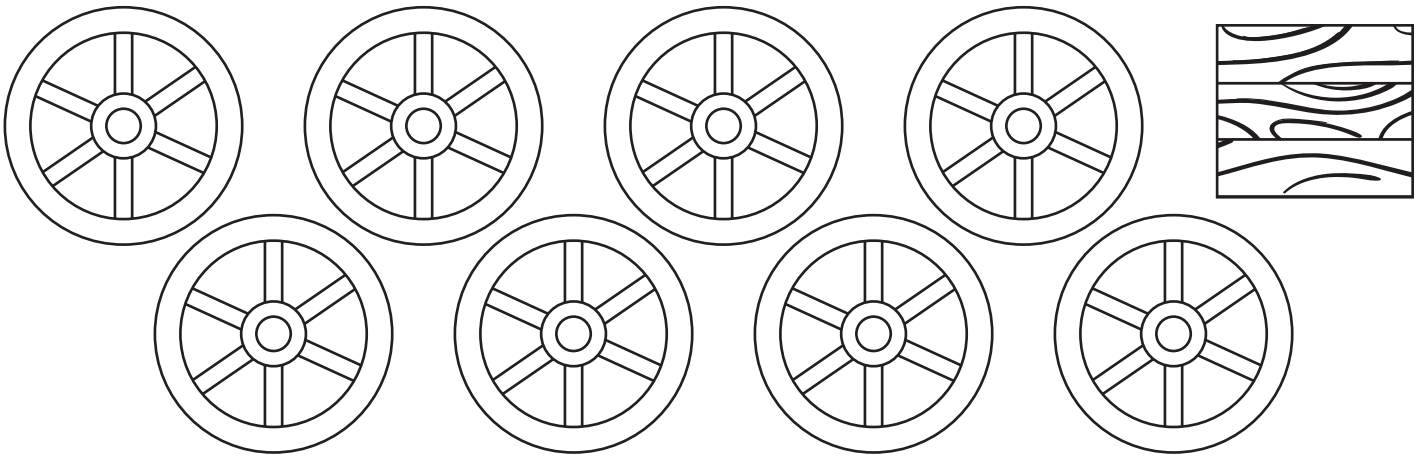

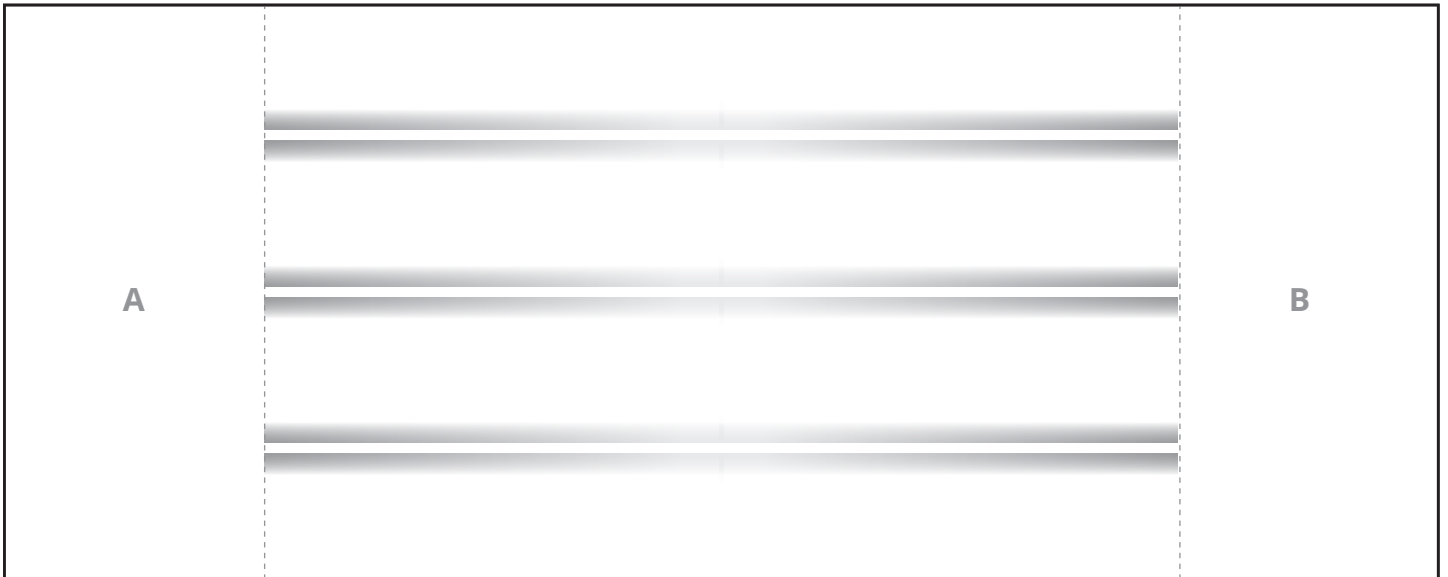
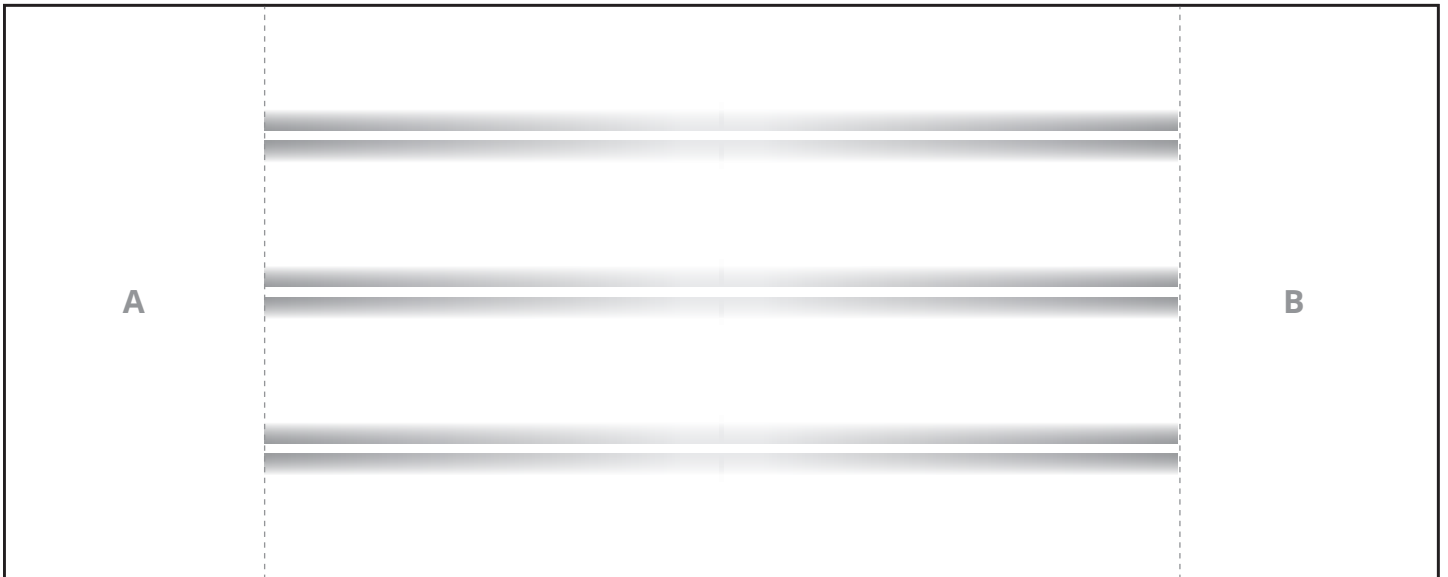

What 1860s method of travel would you like best—train, stagecoach, horseback, or boat?	All the characteristics (tributes) of Jesus are equally important, but if you had to pick one that's particularly important to you, which would you choose?	Jesus was happy at times. What's one of your happiest memories?
If you visited the Grand Canyon, would you be content to stay at the top or would you be adventurous and follow the narrow path to the bottom?	What do you think would have been best about living in the Old West? What would have been the worst thing?	Jesus was tired at times. What's a time you can remember being sooo tired?
What would you do if you came upon a grizzly bear while hiking?	If you had been with the shepherds when the angels appeared, what would your reaction have been?	Jesus was hungry at times. If you were really hungry, what's the first food you'd want to eat?
Which would you rather be: a Pony Express rider, a general store owner, a cowboy/cowgirl, or a gold miner?	If you had been with the wise men, what gift would you have given Jesus?	Jesus would have always treated his siblings perfectly. If you have siblings, what's something you like about each one?
If you were alive in the 1800s, do you think you would have moved out West?	Which instrument would you most like to play: a harmonica, a banjo, or a fiddle?	If you had lived in Nazareth, Jesus would have been a perfect friend. What's a quality you think is important in a friend?
What do you think is most amazing about Jesus' birth?	We learned Jesus is Creator. What's something Jesus has created that amazes you?	We learned Jesus is the King of Kings. What's a quality you think is important in a king?
What do you think is most amazing about Jesus being a child?	Jesus created the animals. What is your favorite animal?	What event in Jesus' life would you most like to have witnessed?
What is one of your favorite wonders that Jesus did?	Jesus created all the plants. What is your favorite plant?	What question would you like to ask God?
How do you feel about Jesus returning some day?	We learned Jesus is Immanuel, which means "God with us." What's one of the best things about God being with you?	What are you thankful for right now?
If you could go back in time, what era would you most like to visit?	Jesus was a carpenter's son. If you had to build something, what would it be?	Share an embarrassing moment.
What's your favorite part of VBS?	Jesus obeyed his parents perfectly. What's something you find difficult to obey?	If you could invent something, what would it be?
What's your favorite VBS theme?	Jesus made the seasons. What's your favorite season?	How does someone become a Christian – a follower of Jesus?
Who is your favorite Bible character? Why?	Jesus was sad at times. What's one of your saddest memories?	What do you think Jesus thinks about you?



Mini Horseshoes Rules

1. First player pitches both horseshoes, followed by the second player.
2. To score points, horseshoes must land inside or on the rim of the horseshoe pit.
3. Scoring:
Shoes on the rim — 1 point;
In the pit — 2 points;
“Ringers” —3 points.
4. First player to reach 21 points wins the game.

Mini Horseshoes Rules

1. First player pitches both horseshoes, followed by the second player.
2. To score points, horseshoes must land inside or on the rim of the horseshoe pit.
3. Scoring:
Shoes on the rim — 1 point;
In the pit — 2 points;
“Ringers” —3 points.
4. First player to reach 21 points wins the game.

ALPHA & OMEGA
TEACHER CREATOR
BREAD OF LIFE CORNERSTONE
JESUS CHRIST
ROCK King of Kings
Living Water CARPENTER Messiah
Savior Light of the World
THE WAY Mighty God
Wonderful Counselor
Son of God **Son of Man**
IMMANUEL

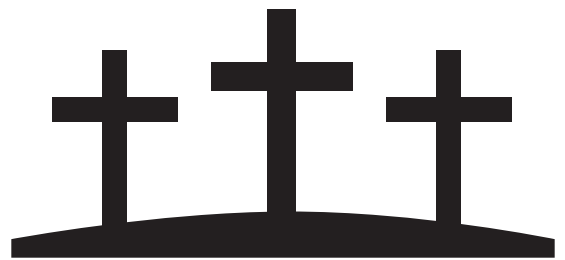
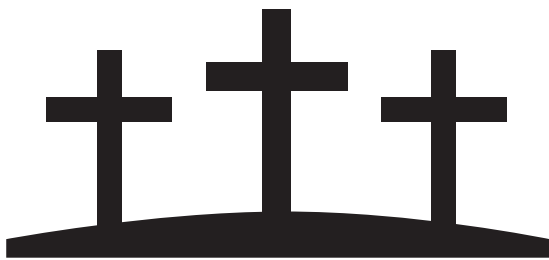
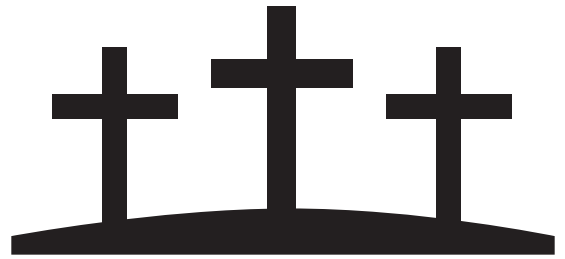
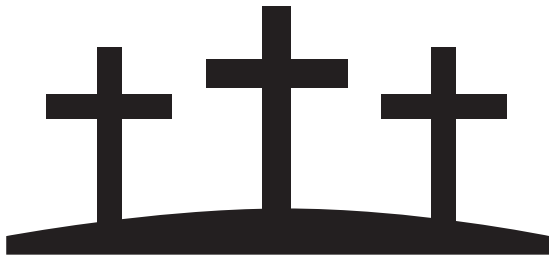
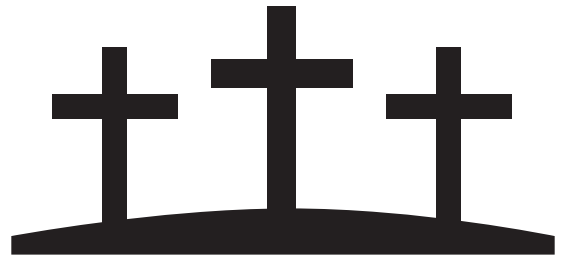
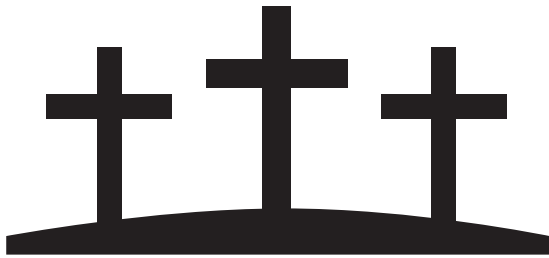
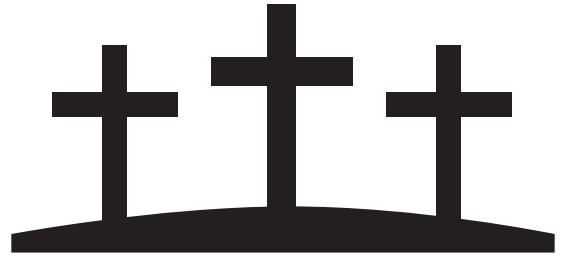
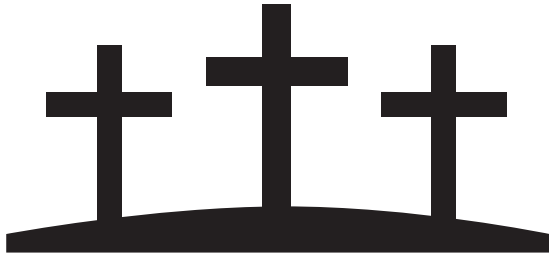
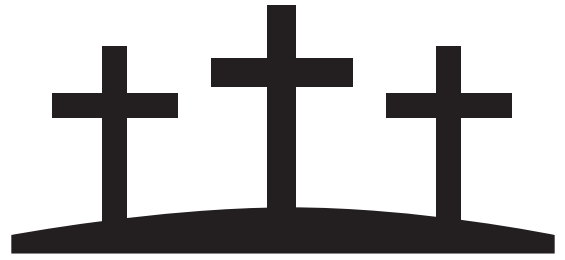
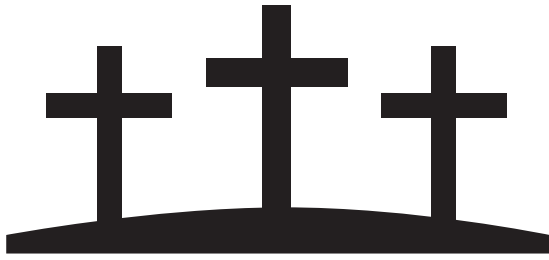

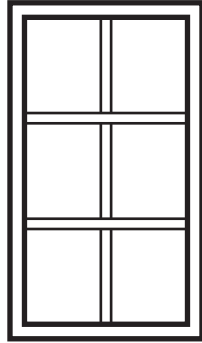
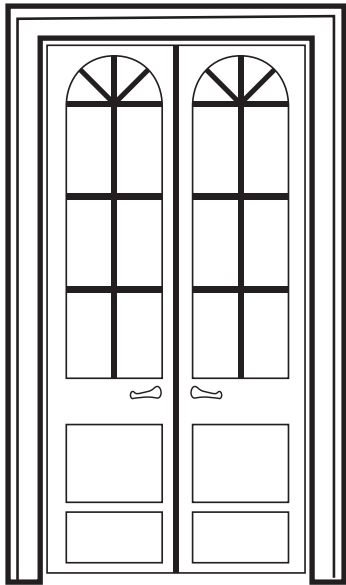

Wonder Junction
BANK

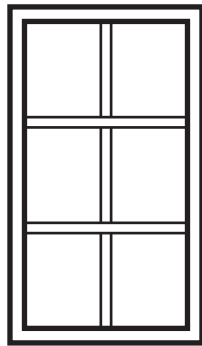
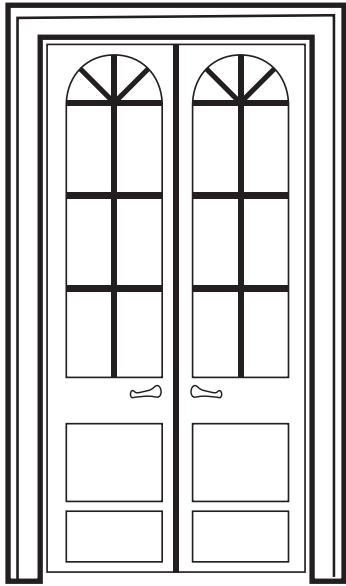
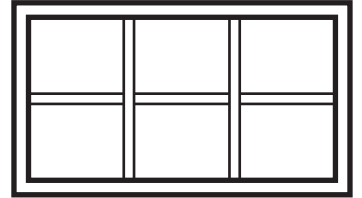
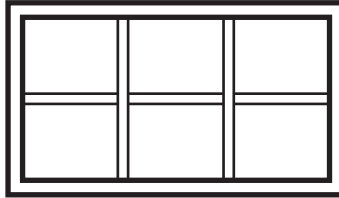

Wonder Junction
BANK

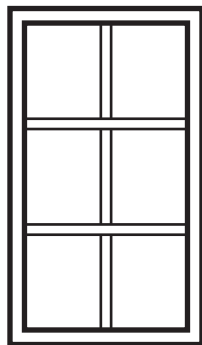
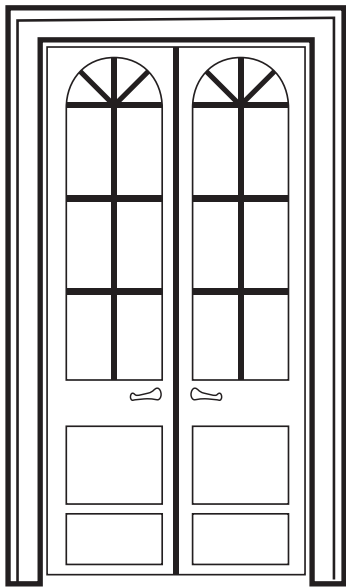
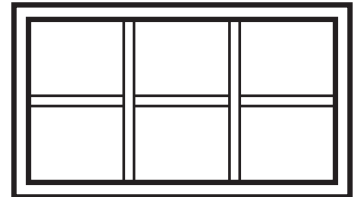
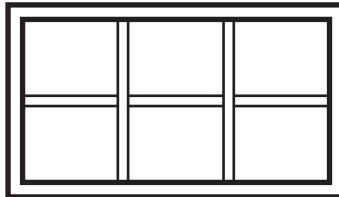

Wonder Junction
BANK

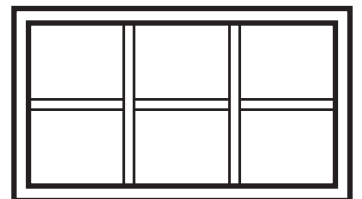
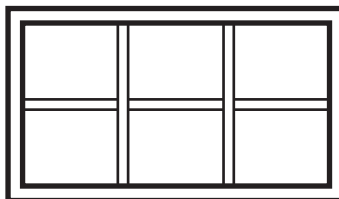

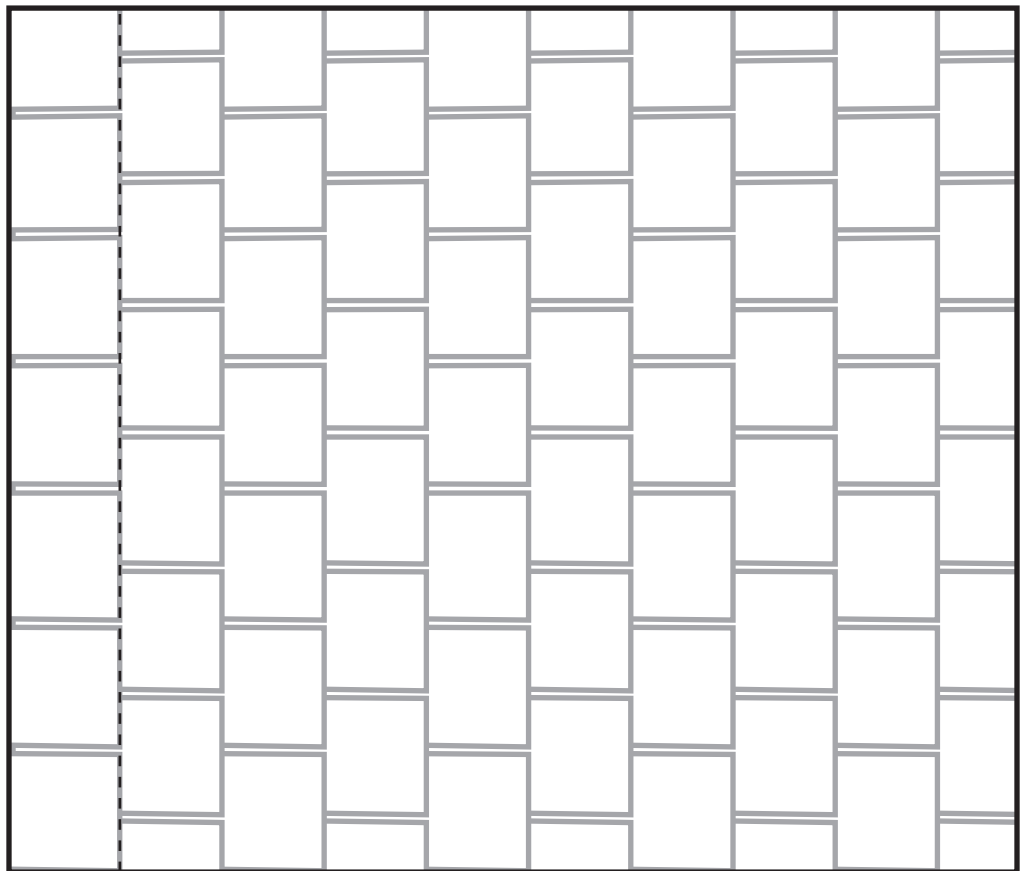
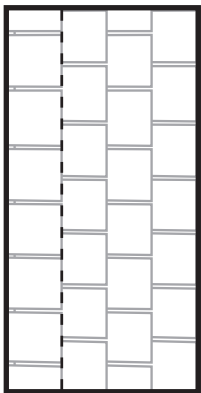
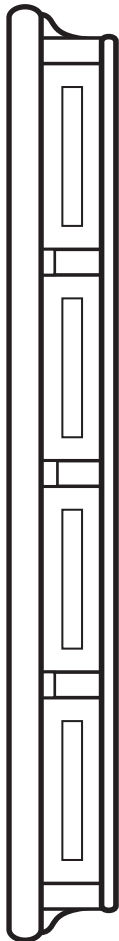
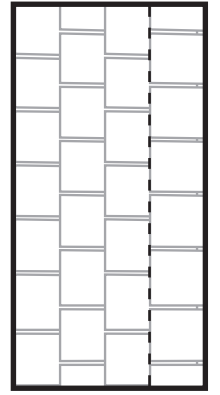
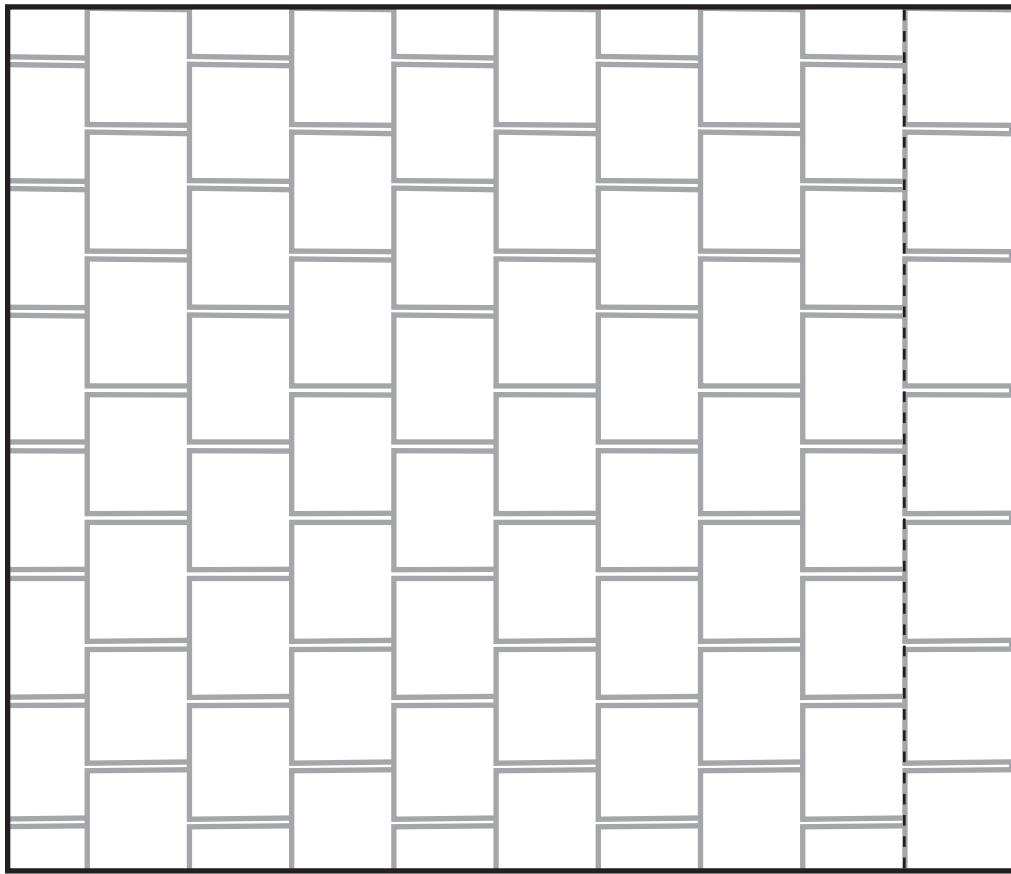

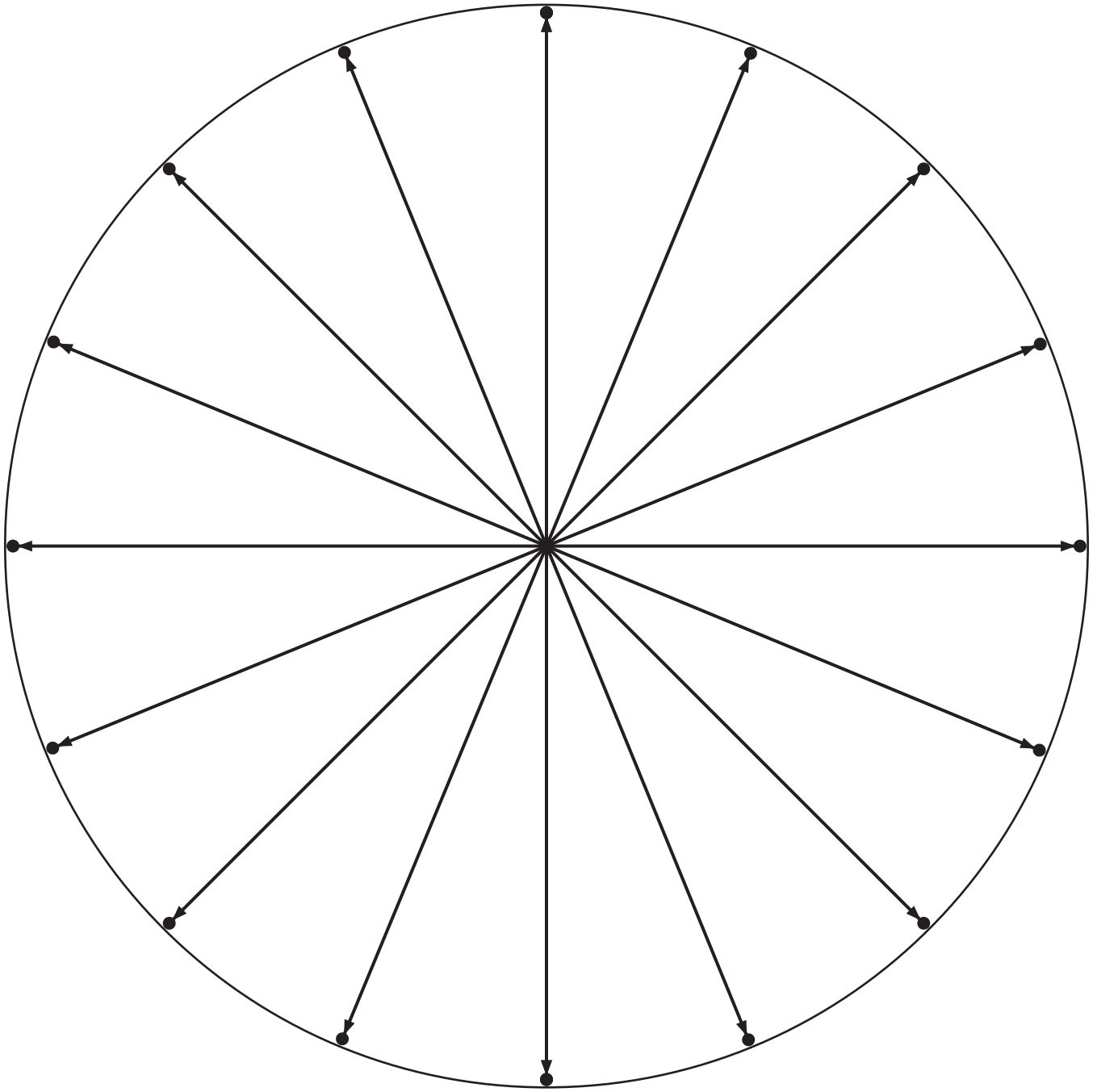

Mark the dots.

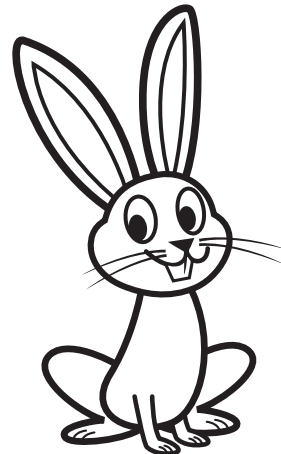
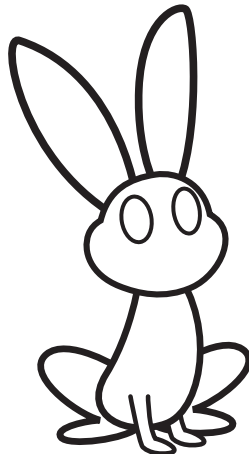
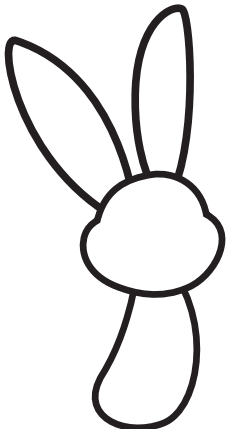
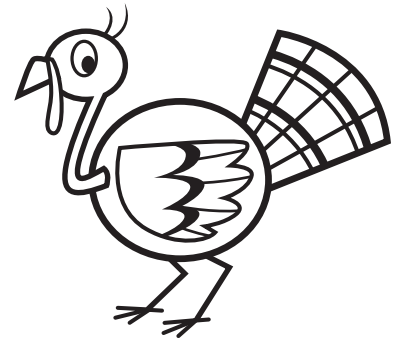
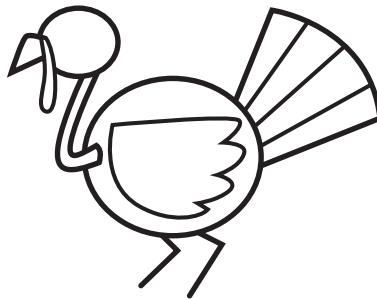
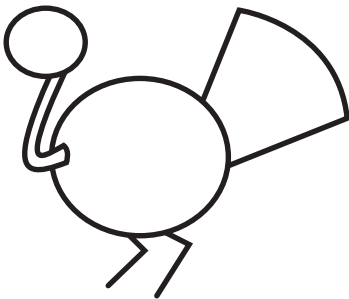
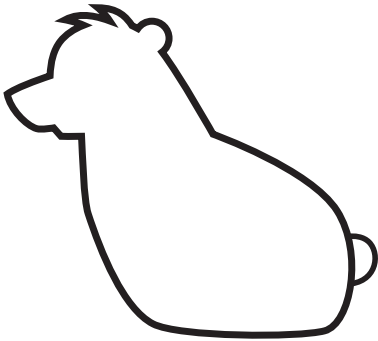
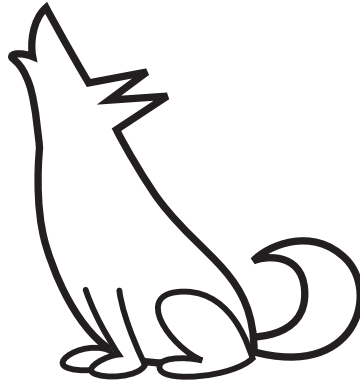

Light
of the
World

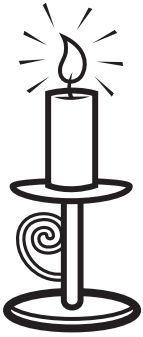

Bread of Life

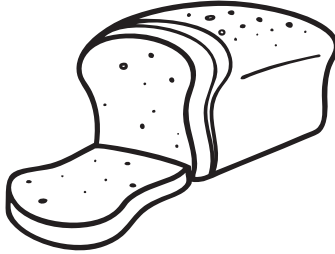

Shepherd



Horn of
Salvation

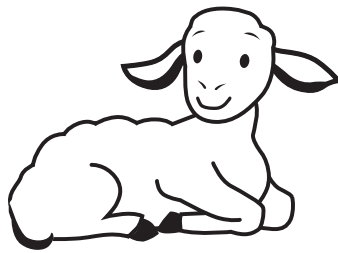

Lamb of God

Lion of the
tribe of Judah

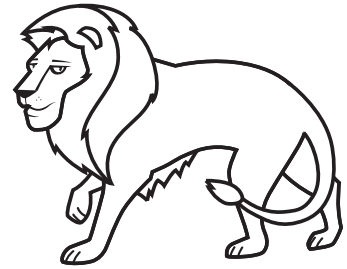

Vine



Branch



Rock

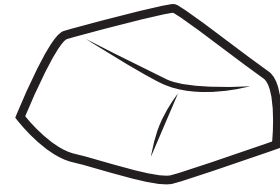

Physician



Bright and
Morning Star

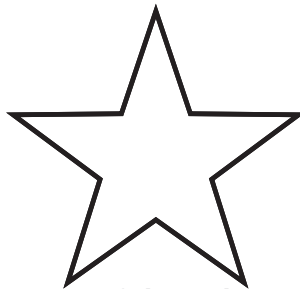

Gift of God

